

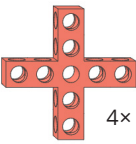

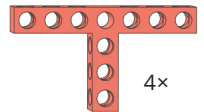

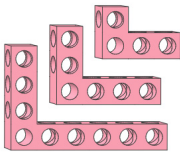

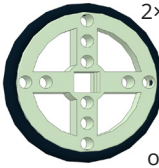

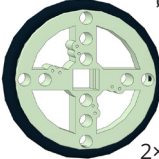
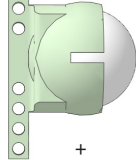
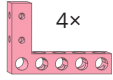
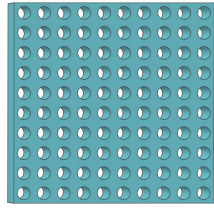
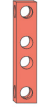





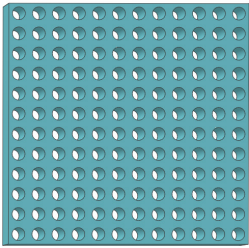
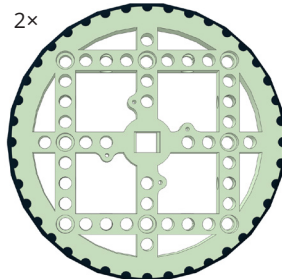
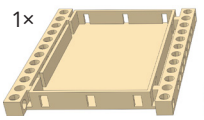

24	● podložky M4 100x	šrouby M4 x 30 40x	 4x	 4x	 4x 4x 4x	 2x o-kroužek ø 51 mm (4x)  2x	 1x + ping-pongový míček 1x
----	-----------------------	-----------------------	--------------------------------------------------------------------------------------	----------------------------------------------------------------------------------------	----------------------------------------------------------------------------------------------------	-----------------------------------------------------------------------------------------------------------------------------------------------------------------------------------------------------------------	----------------------------------------------------------------------------------------------------------------------------

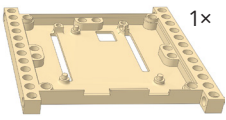

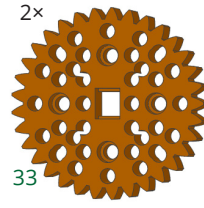
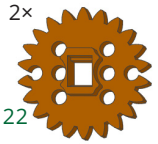



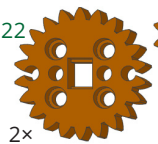

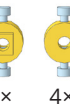
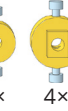

17	● matky M4 100x	šrouby M4 x 20 60x	 4x  1x	magnet v plastu 1x LED červená 2x LED žlutá 2x LED zelená 2x spínač koncový 4x spínač malý 4x potenciometr velký 1x potenciometr malý 2x rezistor 150R 6x rezistor 10K 4x	USB kabel 1x  4x	 3 4x  5 4x  7 4x  9 4x  11 4x  13 4x  15 4x  24 2x	<h2 style="text-align: center;">m-BITBEAM</h2> <p style="text-align: center;">Open source konstrukční robotická stavebnice hojně využívající 3D tištěných dílků. 3D tištěné dílky nejsou součástí sady! Tyto dílky si musí vytisknout a zkompletovat každý sám.</p> <h3 style="text-align: center;">Schema uložení dílků v kufříku</h3>
13	plastový klíč ... 1x						

11	● čidlo zvuku 1x	● ultrazukový dálkoměr 1x
10	● čidlo teploty 1x	● joystick 1x
9	● čidlo magnetického pole 1x	● displej (OLED) 1x
8	● čidlo světla 1x	● bluetooth modul 1x
7	● IR čidlo (překážky/čára) 1x	
6	● RGB LED 1x	
5	● piezo-bzučák 1x	
4	● IR přijímač 1x	

4	 2x	redukce napájení servomotorů 1x
---	----------------------------------------------------------------------------------------	---------------------------------------

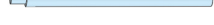
1x		2x		o-kroužek ø 98 mm (2x)
1x		1x		baterie AA 5x nebo 6x
1x		1x		nepájivé pole 400 IR dálkový ovladač 1x

2x		2x		4x		13	
33		2x		2x		2x	

4x		4x		2x		2x		4x		4x		4x		imbusový klíč 2,5 1x
2x		2x		2x		2x		8x		6x		6x		propojovací vodiče samec-samec 20x propojovací vodiče samec-samice 20x

časopis o výuce
e-mole.cz
nejen s digitálními technologiemi